

Dupree Bay®

Seating Capacity.....	2-3 Adults
Dimensions	91 1/2" x 91 1/2" x 40", (233 cm x 233 cm x 102 cm)
Dry Weight.....	835 lbs (379 kg)
Filled Weight (Average Fill)	2,709 lbs (1,229 kg)
Water Capacity (Average Fill).....	225 US gallons (852 Liters)
Shipping Weight	835 lbs (379 kg)
Export Shipping Weight:.....	885 lbs (402 kg)
Electronic Controls	D1 SmartHUB™ full color glass touch control panel; access to control jets, temperature, settings and maintenance schedule
Pump 1.....	North America (60 Hz): 2-Speed, 4.0 HP break, 2.5 HP continuous, 48 Frame
Export (50 Hz):	2-Speed, 2.0 HP continuous
Pump 2.....	North America (60 Hz): 1-Speed, 3.6 HP break, 2.5 HP continuous, 48 Frame
Export (50 Hz):	1-Speed, 2.0 HP continuous
Circulation Pump.....	Yes
Fountain Pump	Yes
Filtration (factory default)	24/7 Filtration (Purge Cycles 2 x 10 minutes)
Total VCR Jets	42
Seat 1 UltraLounge Jets.....	1 Pillow Mini Storm Rotator, 2 Pillow Cluster Shower Directional, 2 Power Storm Dual Rotator, 8 Mini Storm Rotator, 2 Mini Storm Directional, 2 Euro Cluster Storm Rotator, 3 Power Storm Rotator
Seat 2 UltraLounge Jets.....	1 Pillow Mini Storm Rotator, 2 Pillow Cluster Shower Directional, 2 Mini Storm Directional, 6 Euro Cluster Storm Rotator, 8 Mini Storm Rotator, 1 Power Storm Rotator
Massage Selectors	1
Special Features	Tactile Therapy, Spa Status Light, Echo Switch, 2 Flex Therapy Pillow, 2 UltraLounge, 1 Dynamic Massage Sequence
Water Management System.....	UltraPure™ Plus; Two 75 ft filter cartridge; 8" Weir
LED Lighting	Liquid FX™
Optional	Exterior Lights
Synthetic Cabinet Colors.....	Adobe Tan, Stoneridge Grey, Mayan Brown
Terracina Cabinet (Optional).....	Driftwood, Cherry, Summer Pine, Vintage Cedar, Midnight Maple
Acrylic Colors	Moonstone, UltraLife, Sand, Sunstone, Smoked Marble, Blue Topaz, Gray Marble, Desert Stone
Headrests	2 Flex Therapy Pillow
Water Feature.....	Fountain with independent flow rate (on or off) adjustment; powered by the foun- tain pump
Heater	Fast Flow 2.1, 3.4, 5.5 kW
Export (50 Hz):	Fast Flow 2.1, 3.4, 5.5 kW
Electrical Requirements:	North America (60 Hz): 240 VAC@40A or 50A Export (50 Hz): 230 VAC@1x32A, 2x16A, 3x16A or suitably rated circuit breaker to comply with local electrical codes. Certain countries may require dual power inputs
Warranty*.....	North America (60 Hz): Lifetime for UltraLife Shell Structure, 7 Years Acrylic Shell Structure, 5 Years Plumbing, 5 Years Equipment and Controls, Lifetime for EnviroTect Cabinet, 7 Years for Terracina Cabinet, 1 Year Water Purification System, 2 Years for Jet Insert, 1 Year for Jet Escutcheon, 2 Years Lights, 1 Year Stereo; Export (50 Hz): 10 Years for UltraLife Shell Surface, 7 Years Acrylic Shell Surface, 5 Years Plumbing, 5 Years Equipment and Controls, 5 Years for EnviroTect Cabinet, 2 Years for Terracina Cabinet, 1 Year Water Purification System, 2 Years for Jet Insert, 1 Year for Jet Escutcheon, 2 Years Lights, 1 Year Stereo
Audio System (Optional).....	Fully Integrated Stereo System with Bluetooth capability, 4 premium speakers and a subwoofer
Wi-Fi (Optional).....	D1 Connect App



*(See Warranty Document for Specific Details)

Dupree Bay

Massage Selector Diagram

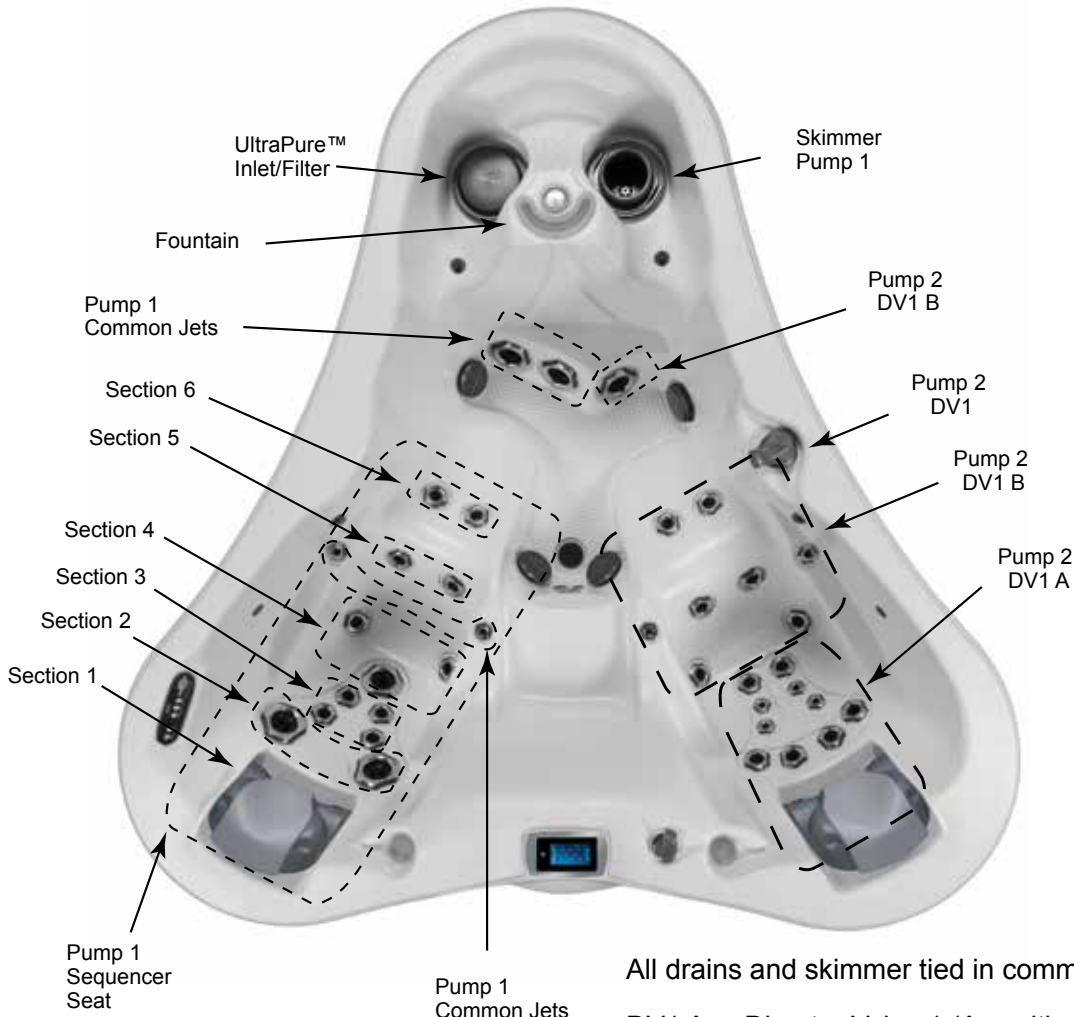

All drains and skimmer tied in common loop.

DV1 A = Diverter Valve 1 (A position counter clockwise).
 DV1 B = Diverter Valve 1 (B position clockwise).
 DV1 C = Diverter Valve 1 (Neutral position).

Spa Operation Subject to Change without Notice

Seat Depths

- 1 = 30.00" (76.20 cm)**
- 2 = 28.00" (71.12 cm)**
- 3 = 19.00" (48.26 cm)**
- 4 = 31.00" (78.74 cm)**

Listed dimensions represent distance from top of acrylic to lowest point in seat. **Tolerance ± 0.5" (1.27 cm).**



Dimensions/Specifications are Subject to Change Without Notice

Dupree Bay

Jet Designation

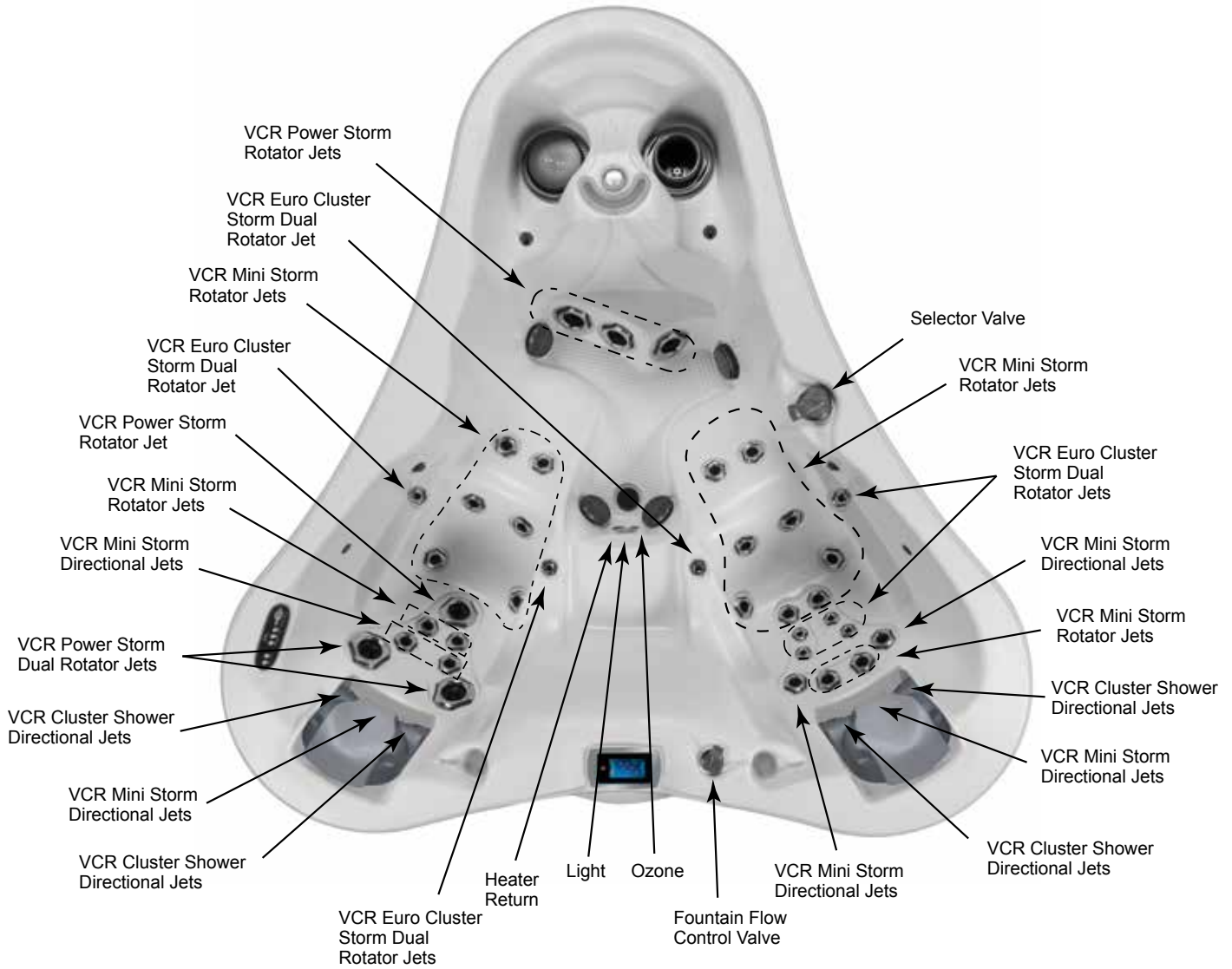



Dimensions/Operation/Specifications are Subject to Change Without Notice

42 Total Jets

Total Jets

- 

Mini Storm Rotator (18)
- 

Mini Storm Directional (4)
- 

Cluster Storm Dual Rotator (8)
- 

Power Storm Rotator (4)
- 

Power Storm Dual Rotator (2)
- 

Flex Therapy Pillow (2)
- 

Cluster Shower Directional (2)
- 

Mini Storm Rotator (1)

Dupree Bay

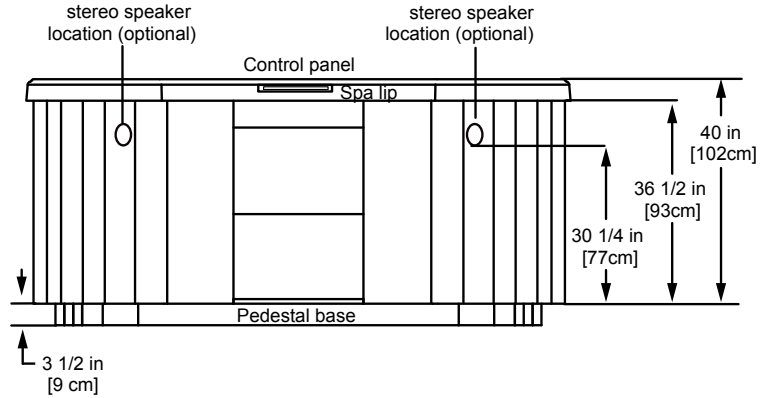
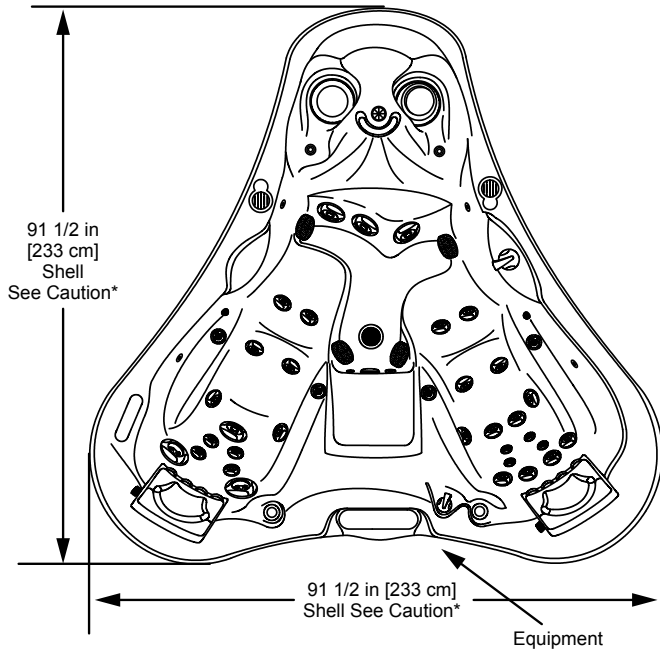

STOP

***Caution:**
 Due to manufacturing tolerances there could be some minor differences between the actual spa and the drawing above.
If site planning is critical to such tolerances, be sure to measure your actual spa.

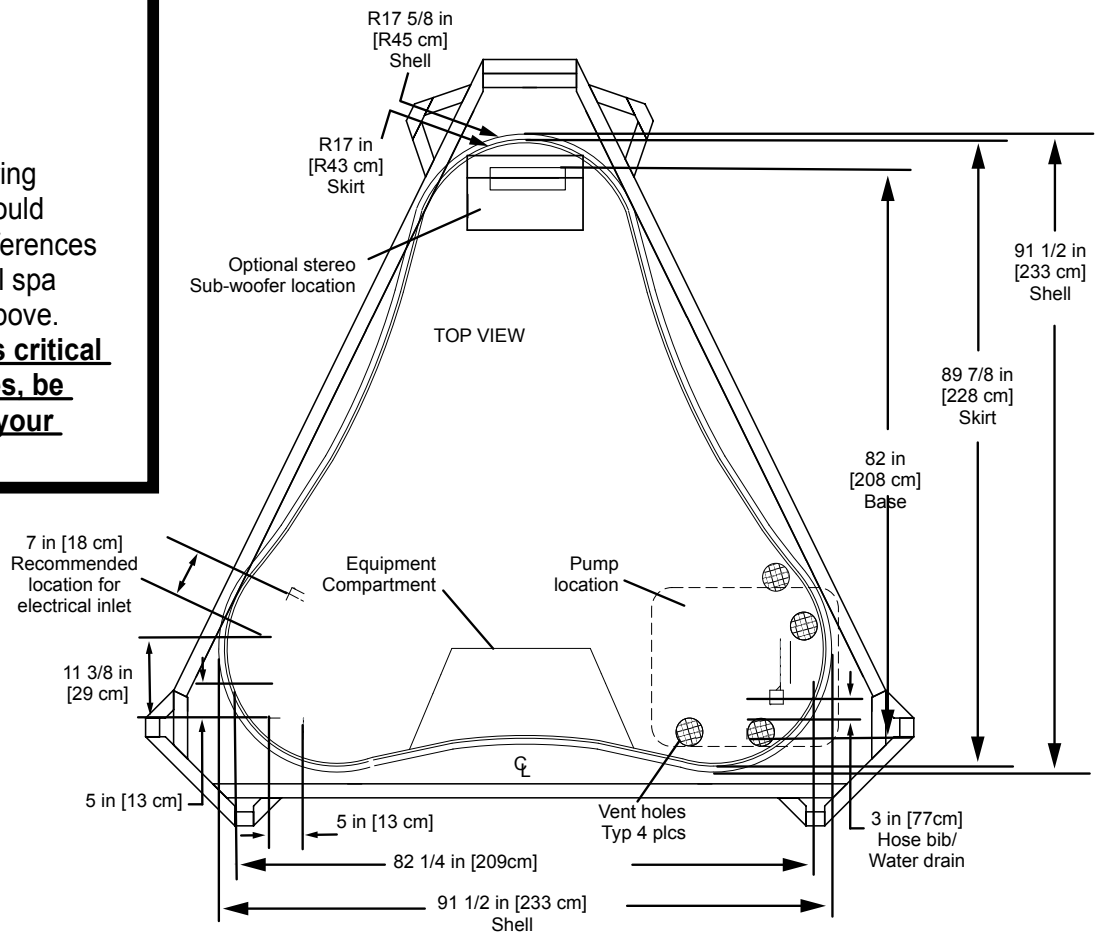

- NOTE: Subject to change without notice
1. Engineering specs may differ slightly from brochure.
 2. For E-Z lifter installation allow 18" (45.72cm) clearances on the backside of the spa.
 3. Alternative cabinets may add significant weight. Ask your dealer for exact details.

Dimensions/Specifications are Subject to Change Without Notice (Tolerance ± 0.5" [1.27 cm]).