

General		
Shape	Free form / Rectangle	
Seating Capacity	7	
Shell Material	Ultralife™ / Geloy®	
Dimensions	108" x 92" x 40" H / (275cm X 234cm x 102cm H)	
Corner Radii	N/A	
Water Capacity	415 Gallons (1571 Liters)	
Dry Weight	1011lbs (459 kg)	
Shipping Weight	Domestic 1011 lbs (459 kg) - Export 1061 lbs (481 kg)	
Full Weight	4467 lbs (2026 kg)	
Skirt Material	Synthetic	
Poly Floor	Yes	
Water System		
Water Treatment System	UltraPure® Plus	
Plumbing Systems	5	
Filters/Coverage	2 / 75 sq. ft.	
Gate Valves	6	
VCR Jet® - Air Adjustable/Directional	2	
VCR Jet® - Directional	1	
VCR Jet® - Rotator	2	
VCR Jet® - Dual Rotator	4	
VCR Jet® - Multi Port Spinner	2	
VCR Jet® - Mini Rotator	22	
VCR Jet® - Mini Directional	10	
VCR Jet® - Euro Directional	2	
VCR Jet® - Euro Rotator	8	
VCR Jet® - Mini Directional in NFJ	8	
Typhoon Jet	1	
Ozone Jet	1	
Heater Return Jet	1	
Pump Returns	6	
Diverter Valves	2	
Floor Drains	1	
Skimmer	8" Weir	
Special Features		
Dynamic Massage Sequencer w/ control panel	Yes	
NeckFlex® Jet Pillows	2	
Bartop Lighting	Yes	
Stereo system	Optional Poly-Planar	
Water Feature	Yes	
Water Feature Volume control	Yes	
Cup Holders	2	
Tactile Therapy	Floor pedastal / Arms	
Under water magnetic switch	Yes	
Fountain Diverter	Yes	
Pump Information		
	Domestic (60Hz)	Export (50Hz)
Motor Size – Peak (Continuous) HP	3.6 (2.0) HP	3.6 (2.0) HP
Jet Pumps # of Pumps/Speed	One / Dual & Two / Single	One / Dual & Two / Single
Circulation pump	1	1
Fountain pump	1	1
Electrical System		
	Domestic (60Hz)	Export (50Hz)
Voltage	240	240
Amperage	50/40	2X16 / 1X32 3X16
Heater	FastFlo 2.7,4.0,5.5 kW	FastFlo 3.3 kW 2.1, 5.2 kW
Thermostat	Electronic	Electronic
Light	Multi color LED	Multi color LED
Control System	MSPA-MP-D16	MSPA-MP-D14-CE
Upper Control (programmable)	M-Drive with Scrolling Message Center	M-Drive with Scrolling Message Center
Auxiliary Upper Control	No	No

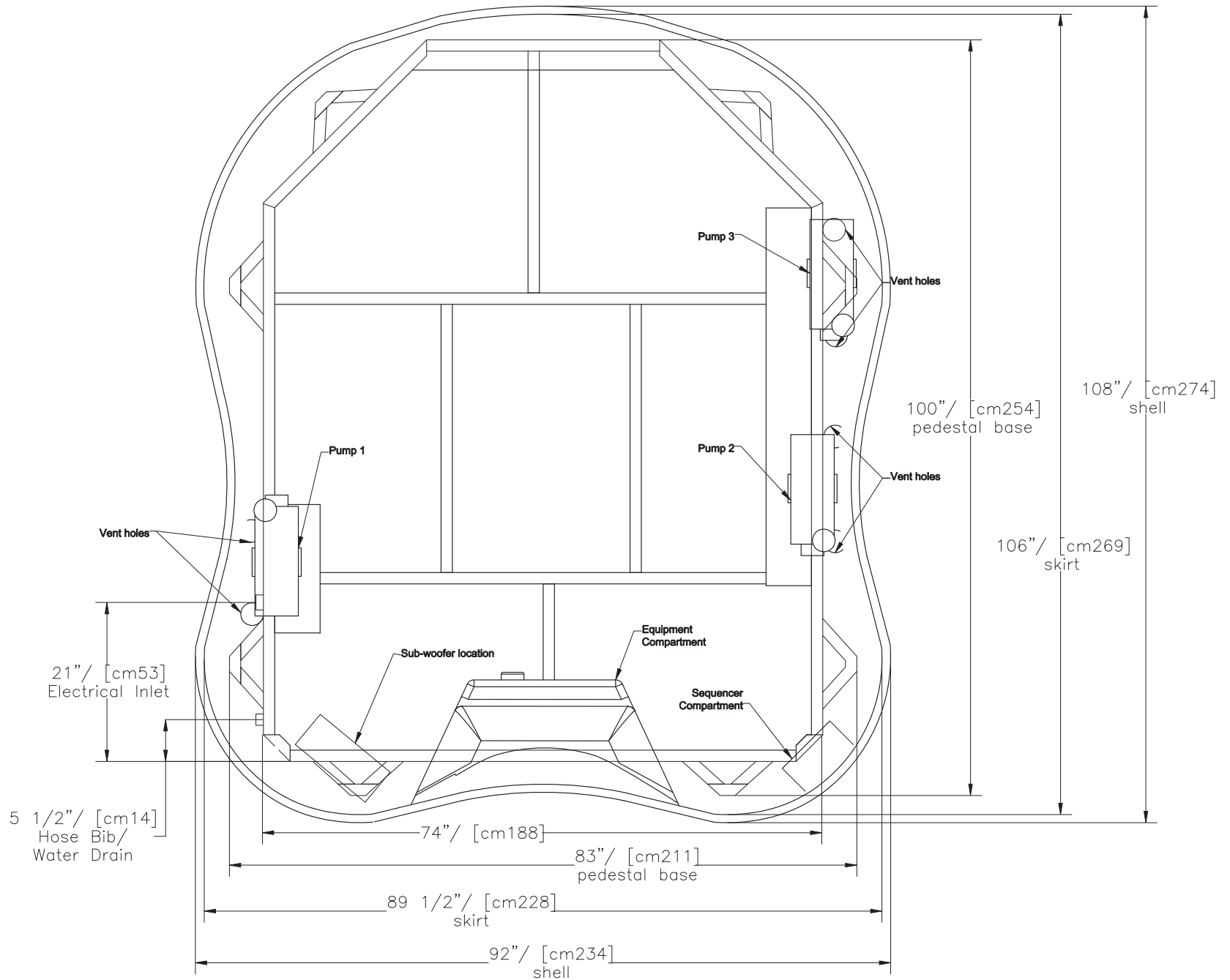

Note: 1. Subject to change without notice.

Amore Bay Architectural Specification



Top View Of Spa

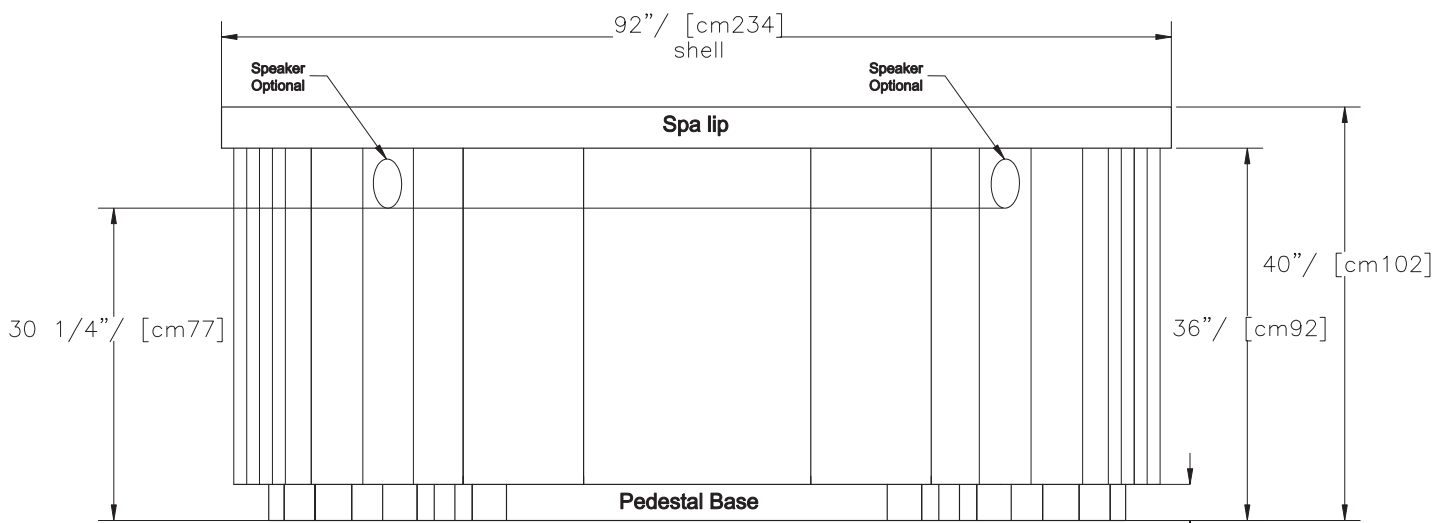

Front View Of Spa

Caution:
Due to manufacturing tolerances there could be some minor differences between the actual spa and the drawing above. If site planning is critical to such tolerances, be sure to measure your actual spa.

- Note:**
1. Subject to change without notice.
 2. Engineering specs may differ slightly from brochure.
 3. For E-Z lifter installation allow 18" (45.72cm) clearances on the backside of the spa.
 4. Alternative cabinets may add significant weight. Ask your dealer for exact details

Dimensions shown as inches and (centimeters) -XX" (cm)

Amore Bay Plumbing Configuration

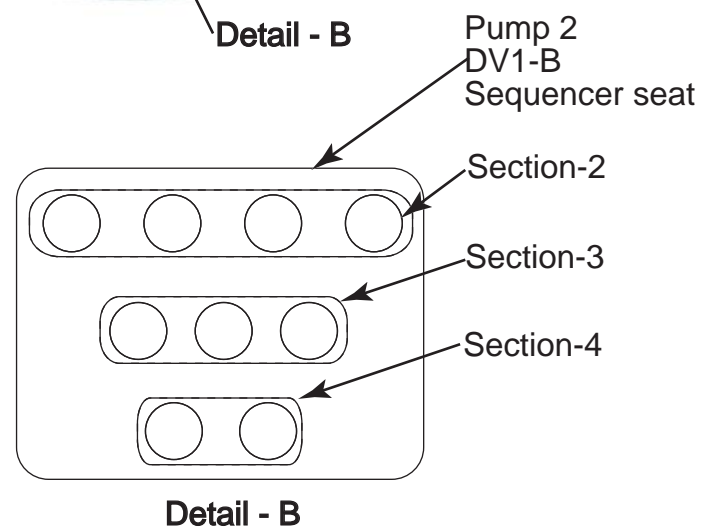
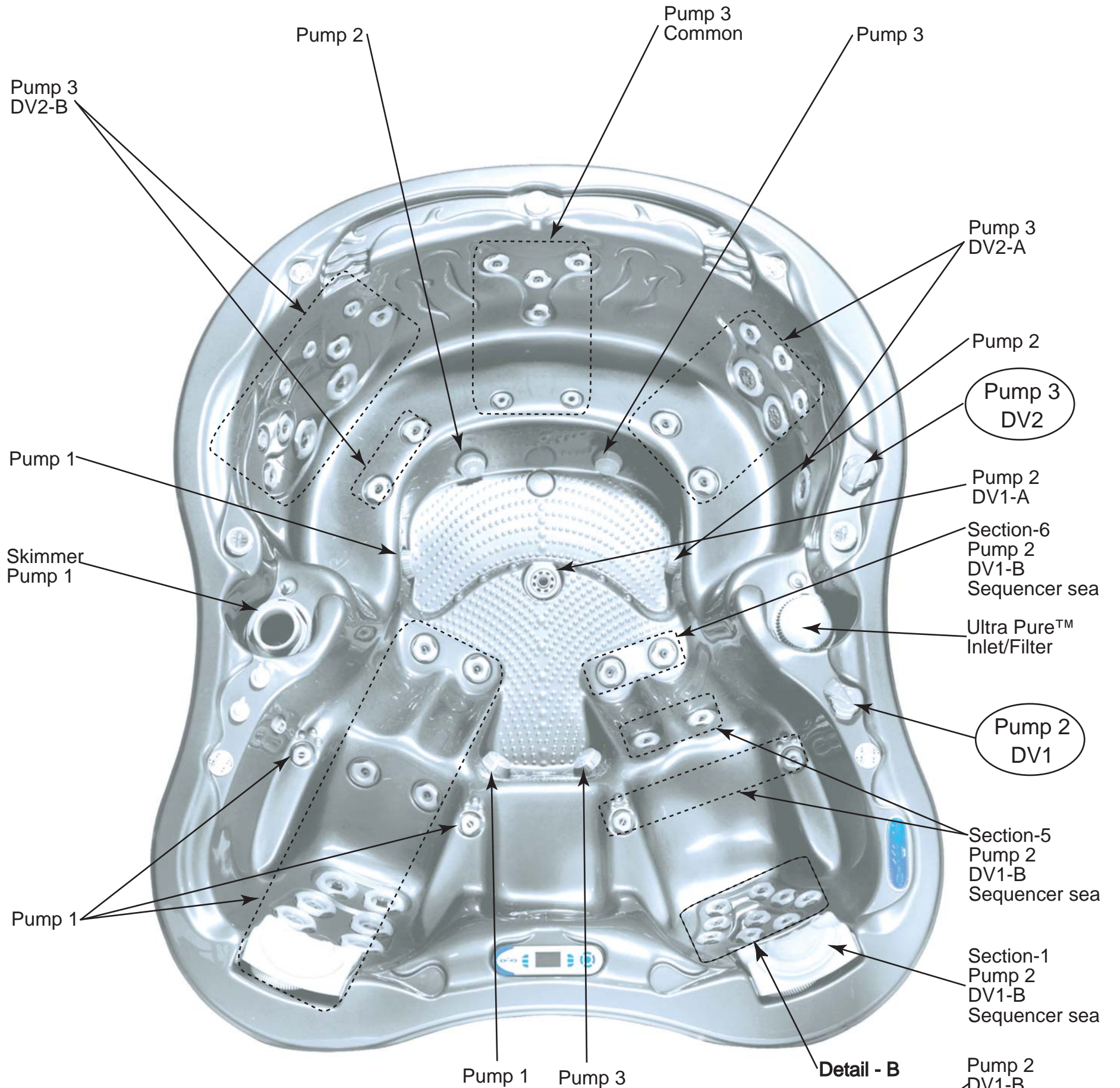

- DV1 A =Diverter Valve 1 (A Position Clockwise)
- DV1 B =Diverter Valve 1 (B Position Counter Clockwise)
- DV1 C =Diverter Valve 1 (Neutral Position)
- DV2 A =Diverter Valve 2 (A Position Clockwise)
- DV2 B =Diverter Valve 2 (B Position Counter Clockwise)
- DV2 C =Diverter Valve 2 (Neutral Position)

Note: 1. Subject to change without notice.
 2. All drains and skimmer tied in common loop.

Amore Bay Jet Insert Designations

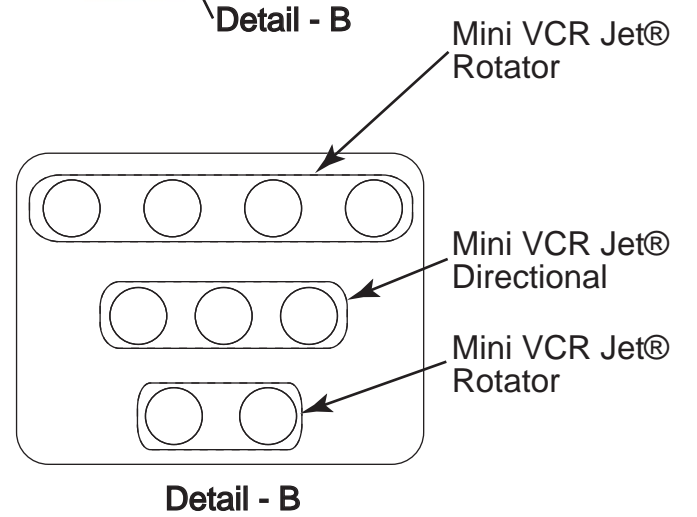
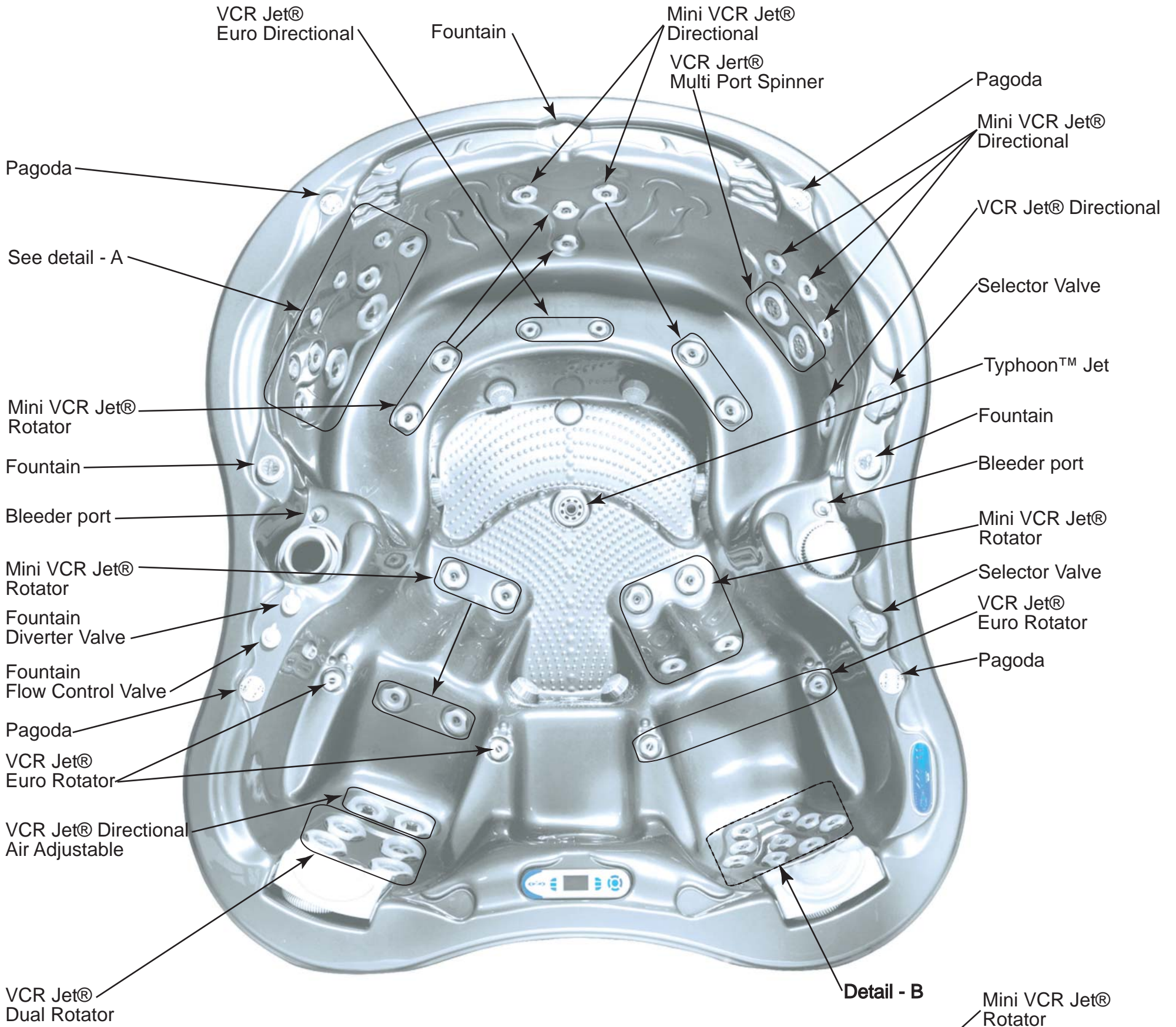
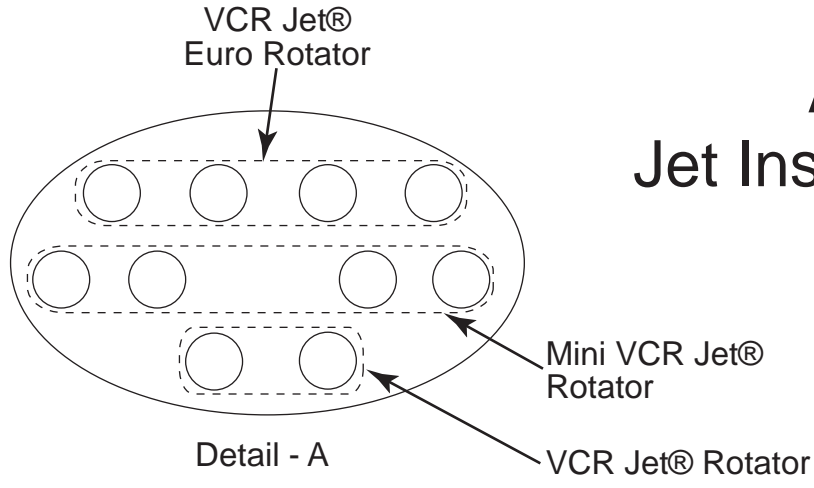

Note: 1. Subject to change without notice.
 2. Reference Doc 1266 Rev A.